

















PRODUCT	TYPE	WATTAGE	MODEL no.	TOTAL LUMEN OUTPUT	BEAM ANGLE	INPUT VOLTAGE	PF	Efficacy	WEIGHT	SIZE mm	LIST PRCE
  	ECO FLOOD 50 W	50	CFECOFL50	4500	120°	UNIV 100-277V	>.9	>80%	1.92 KG	220*282*113	Enquire
   	ECO FLOOD 100 W	100	CFECOFL100	8500	120°	UNIV 100-277V	>.9	>80%	5.37 KG	268*310*182	Enquire
   	ECO FLOOD 150 W	150	CFECOFL150	12750	120°	UNIV 100-277V	>.9	>80%	6.57 KG	298*365*187	Enquire
   	ECO FLOOD 200 W	200	CFECOFL200	17000	120°	UNIV 100-277V	>.9	>80%	8.52 KG	344*465*197	Enquire
	POLE MOUNT BRACKET	all wattages	CFECOFLBRA						2.3 KG	L260*W122*H106	Enquire

PHILIPS LUMILEDS

MW MEAN WELL Power Supply Equipped

UL US

DLC LISTED

RoHS COMPLIANT

MATERIAL	Aluminum Alloy & Glass
WORKING TEMP:	-40- +55
Frequency	50-60 Hz
C.R.I.	80
IP RATING	IP65
COLOR TEMPERATURE	5700 K - STANDARD - CUSTOM OPTIONS AVAILABLE
HOUSING COLOR	BLACK

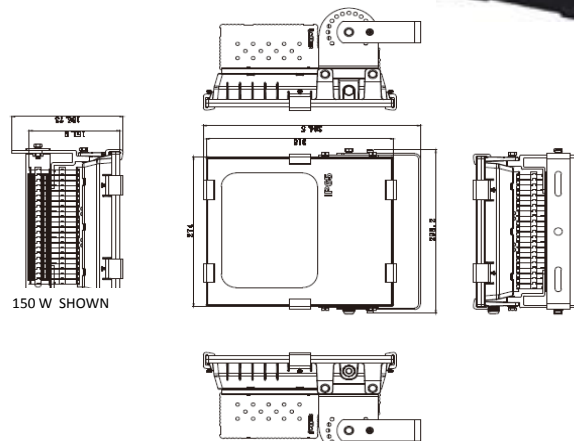
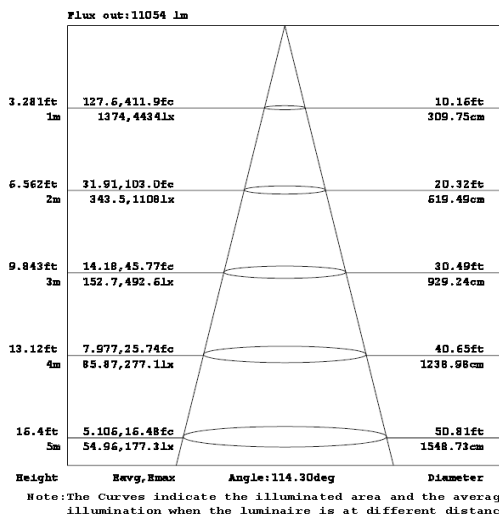

HEAD OFFICE - EDMONTON

18805 87A Ave  
Edmonton AB T5T 5Z7  
ph: 780 - 905 - 3970  
Fax 780-489-9441

BC REGIONAL HEAD OFFICE

9338 Lochside Drive  
Sidney, BC V8L 1N7  
PH: 250 - 213-5070  
Fax 250 - 656-1392